

UCLA Screw Retained Crown for Tissue Level Implant

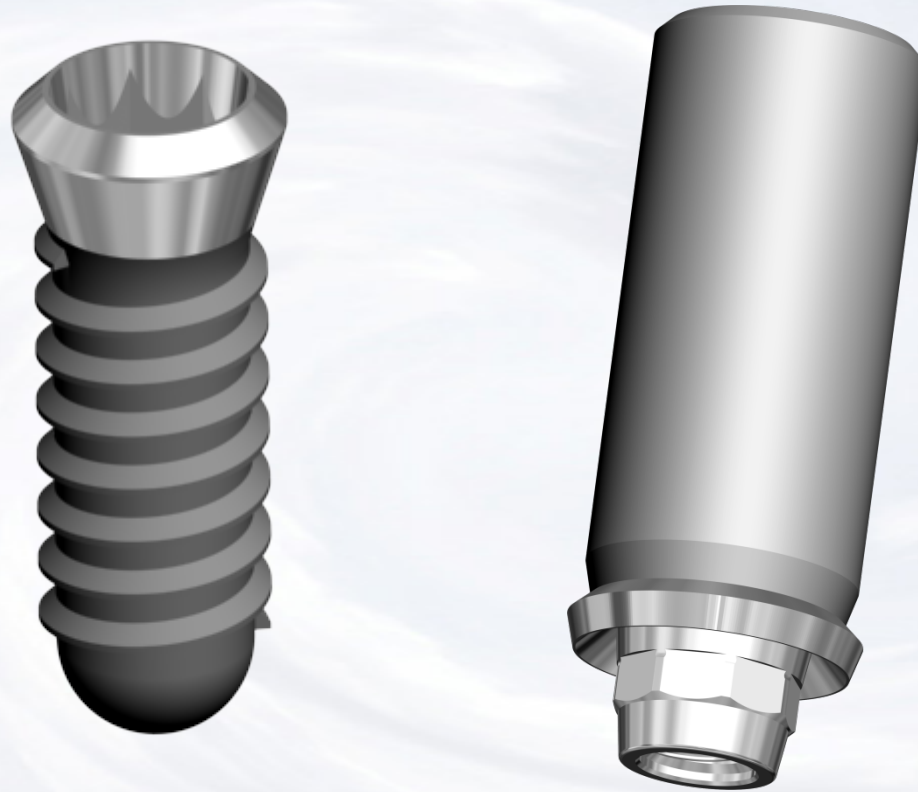

Blue Sky Bio

UCLA Screw Retained Crown for Tissue Level Implant







Cover screw in place

The presentation that follows lists only one combination of parts. Obviously the clinical situation may call for substitution of another part on this slide



Blue Sky Bio

UCLA Screw Retained Crown for Tissue Level Implant

	Size	Part #
	Torque/Ratchet Wrench	TR-900-01
	Thumbwheel/ITI Wrench Adapter	ITI-Adapter
	.048 Hex Driver short	SDS048
	.048 Hex Driver long	SDL048

Prosthetic instruments needed



Blue Sky Bio

UCLA Screw Retained Crown for Tissue Level Implant

Firmly insert the head of the Hex Driver into the Thumbwheel

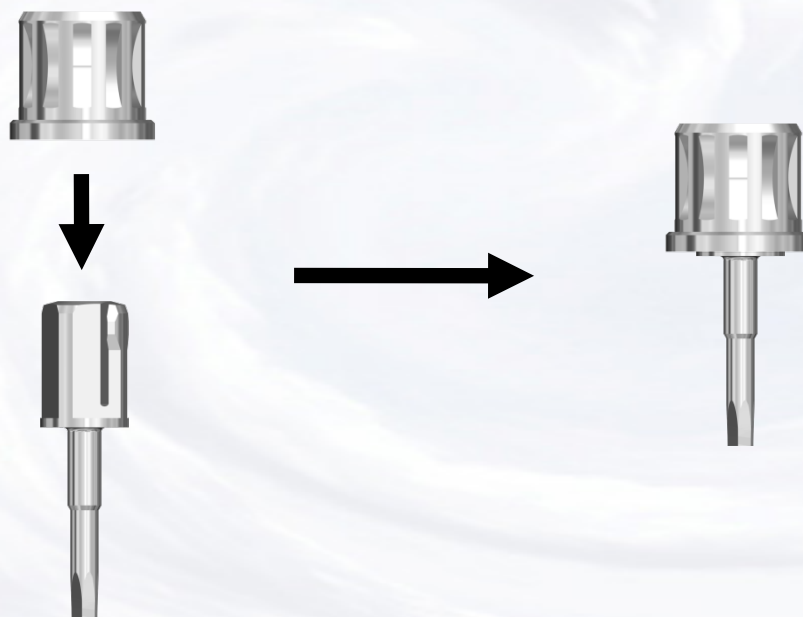

Blue Sky Bio

UCLA Screw Retained Crown for Tissue Level Implant

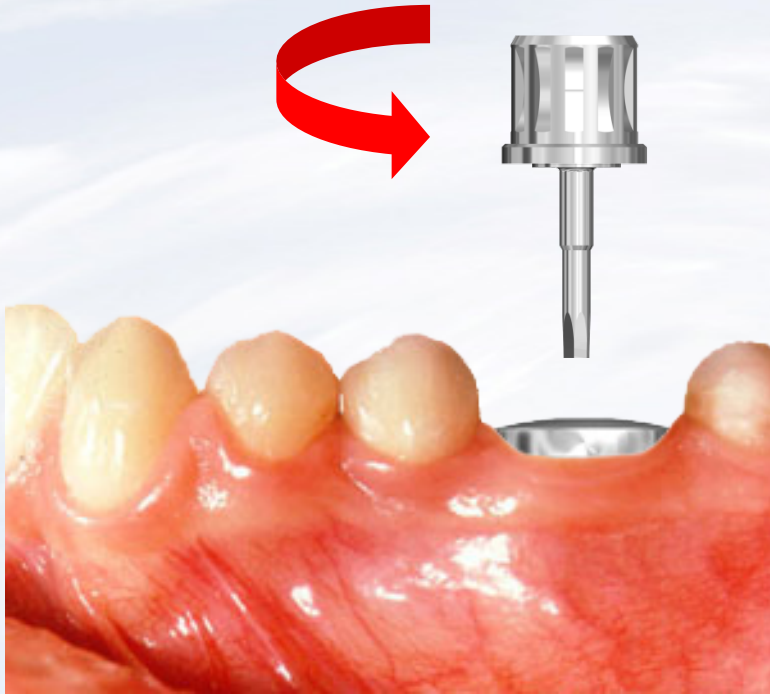

Assemble screw driver with ITI - Adapter (thumb-wheel / adapter)
Insert assembled screw driver into cover screw and turn counter clockwise

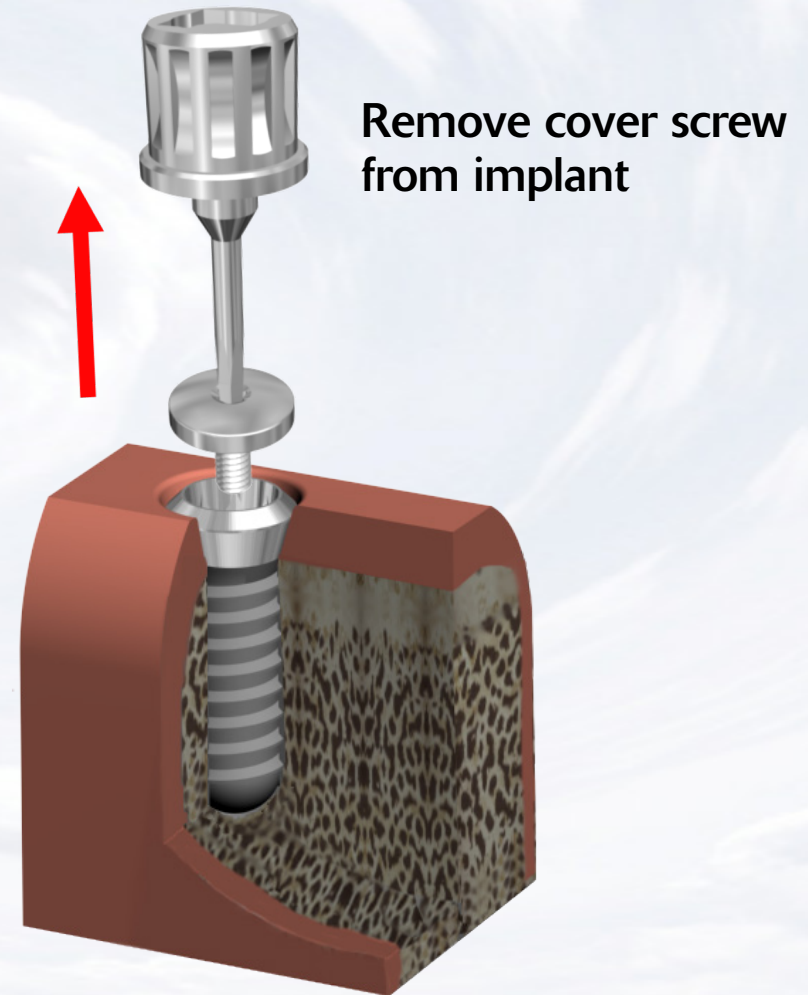

Blue Sky Bio

UCLA Screw Retained Crown for Tissue Level Implant

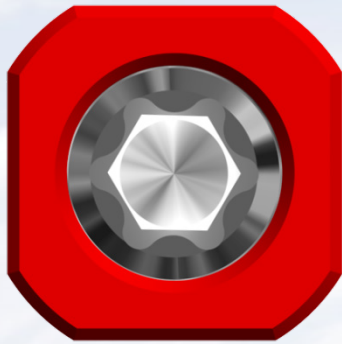

Overhead view on impression transfer shows the center screw within the transfer
The screw can spin separately from the impression coping

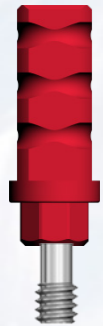

Side view of impression transfer

Male octagon at the base of the impression transfer matches the female octagon within the implant

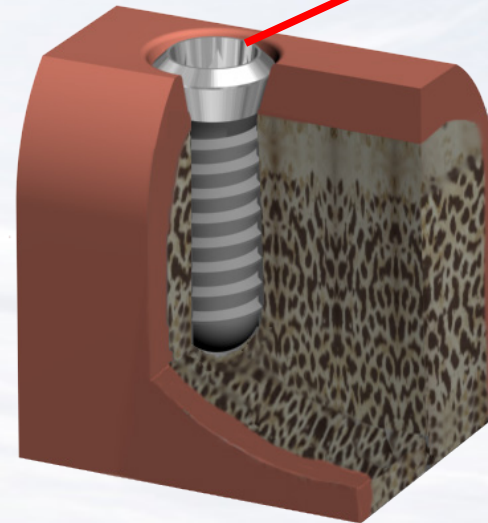
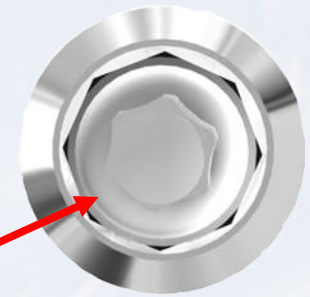

Blue Sky Bio

UCLA Screw Retained Crown for Tissue Level Implant

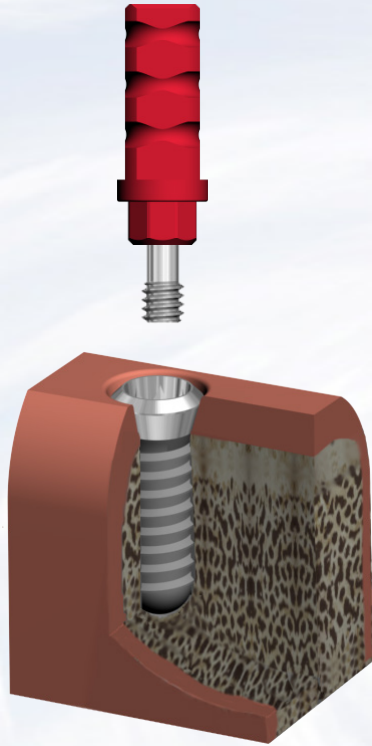

Insert screw into impression coping
Insert the impression transfer into implant and rotate until male octagon of the transfer is aligned with female octagon of the implant and transfer



Use driver assembly to tighten screw clockwise with light finger pressure

UCLA Screw Retained Crown for Tissue Level Implant



Remove screwdriver assembly

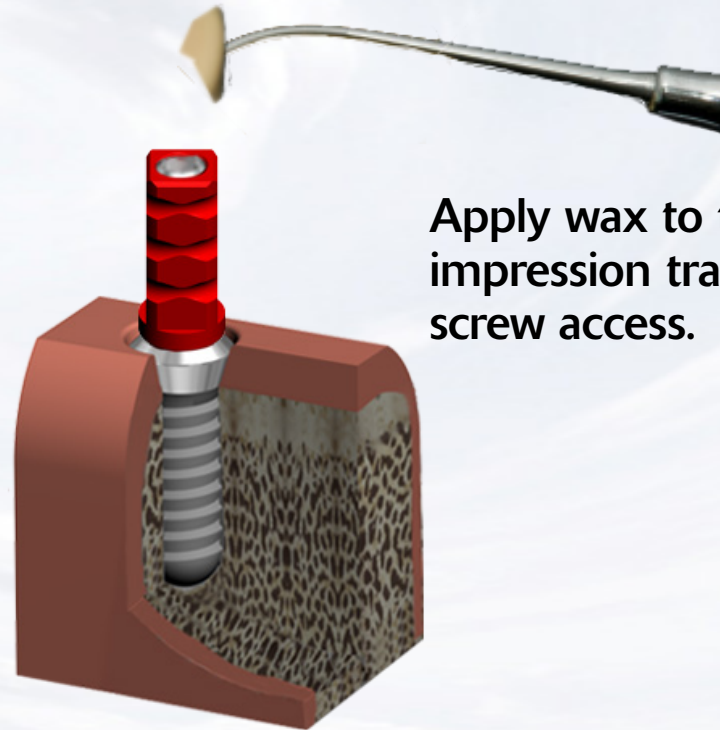

Apply wax to the top of the impression transfer to seal screw access.



Blue Sky Bio

UCLA Screw Retained Crown for Tissue Level Implant



Inject impression material around the impression transfer



Blue Sky Bio

UCLA Screw Retained Crown for Tissue Level Implant

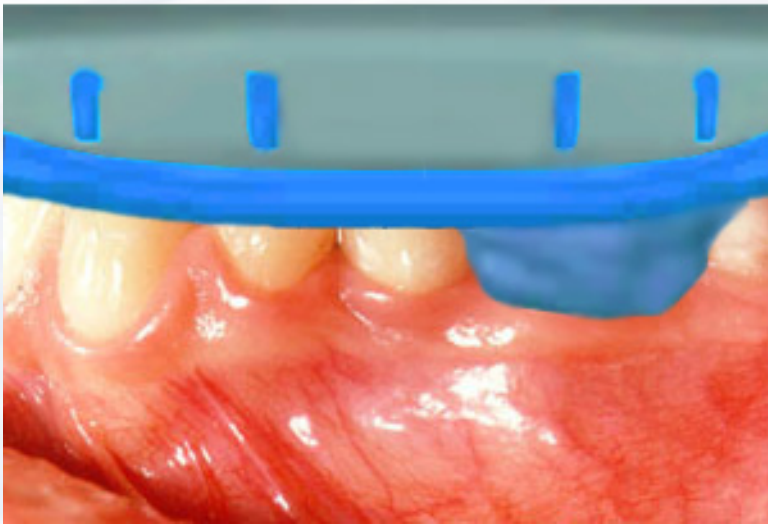

Insert tray with impression material

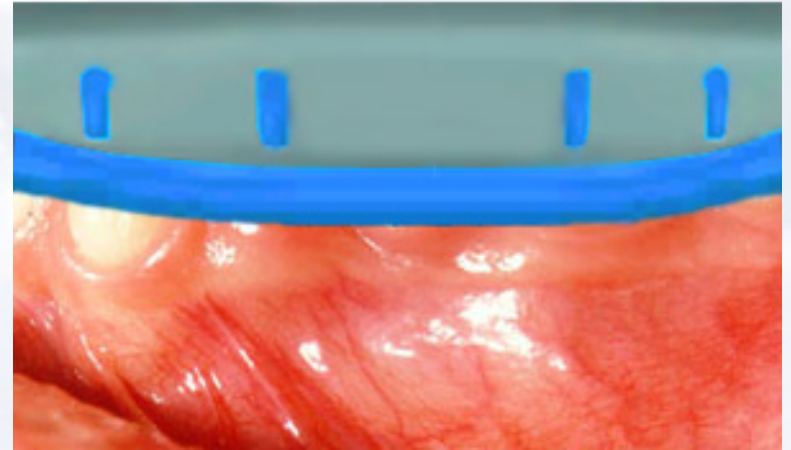

Seat impression to capture dental arch



Blue Sky Bio

UCLA Screw Retained Crown for Tissue Level Implant

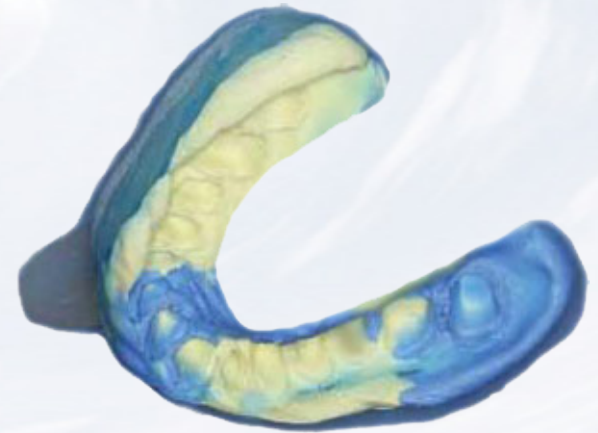
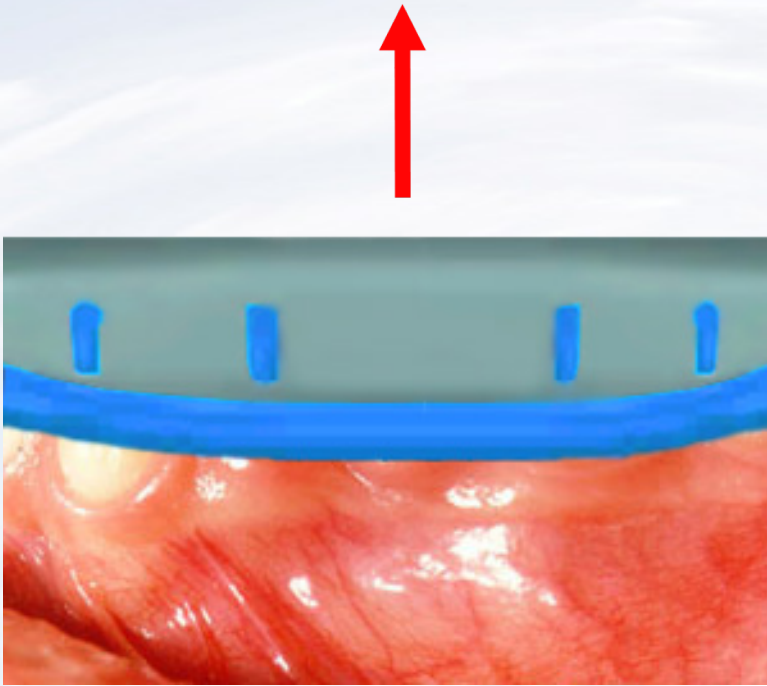

Remove the impression from the mouth when material has set



Blue Sky Bio

UCLA Screw Retained Crown for Tissue Level Implant

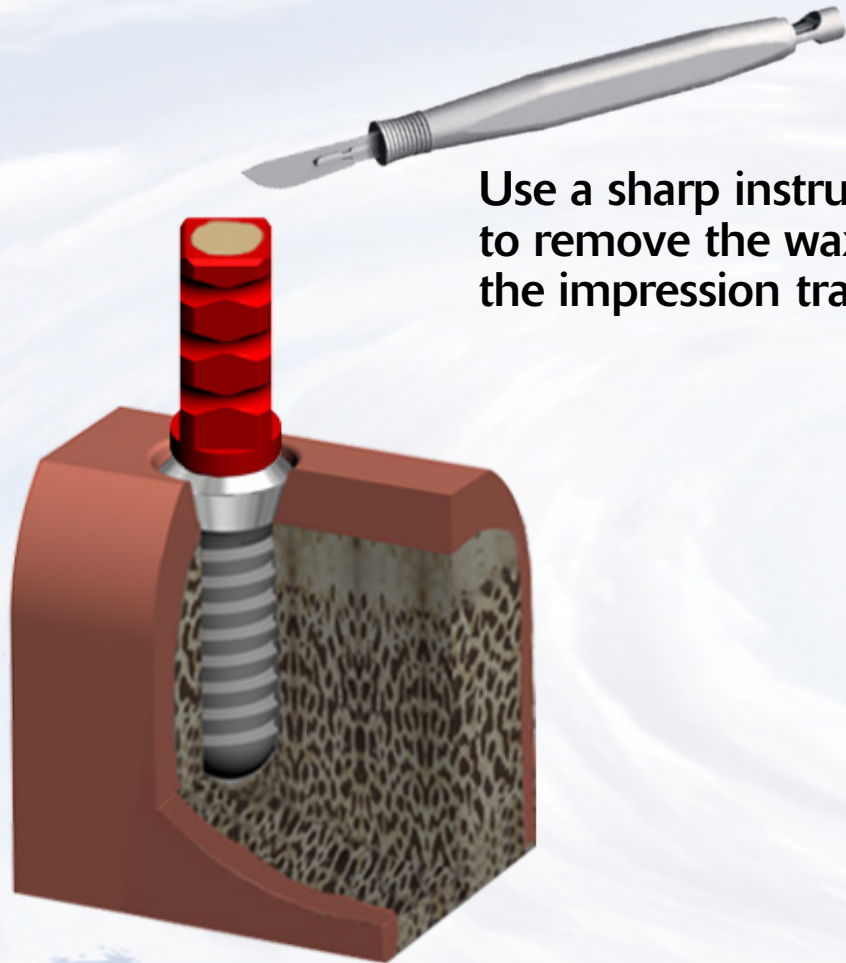

Use a sharp instrument to remove the wax from the impression transfer

Remove impression transfer from implant



Blue Sky Bio

UCLA Screw Retained Crown for Tissue Level Implant

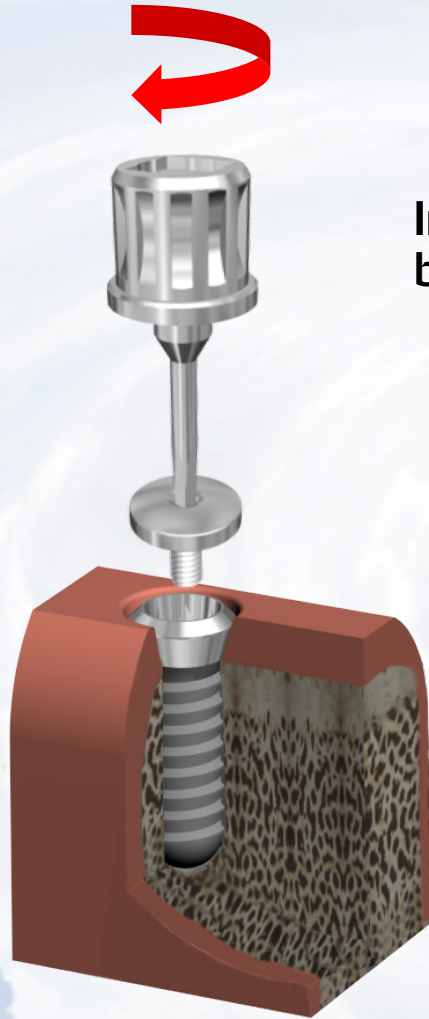

Insert cover screw
back into implant



Cover screw in place



Blue Sky Bio

UCLA Screw Retained Crown for Tissue Level Implant

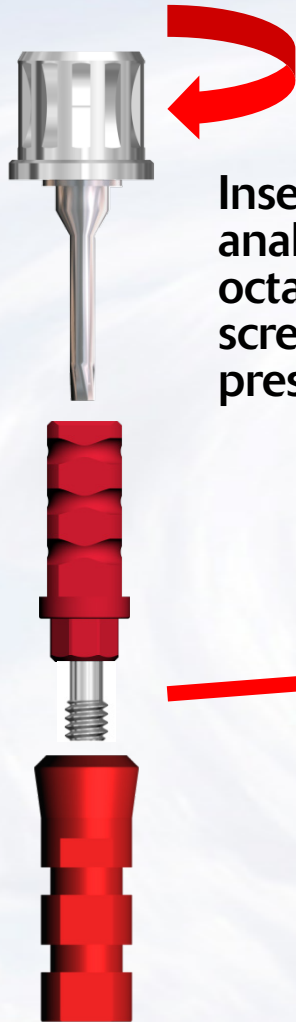

Insert impression transfer into analog matching the respective octagons and turn fixation screw clockwise with finger pressure

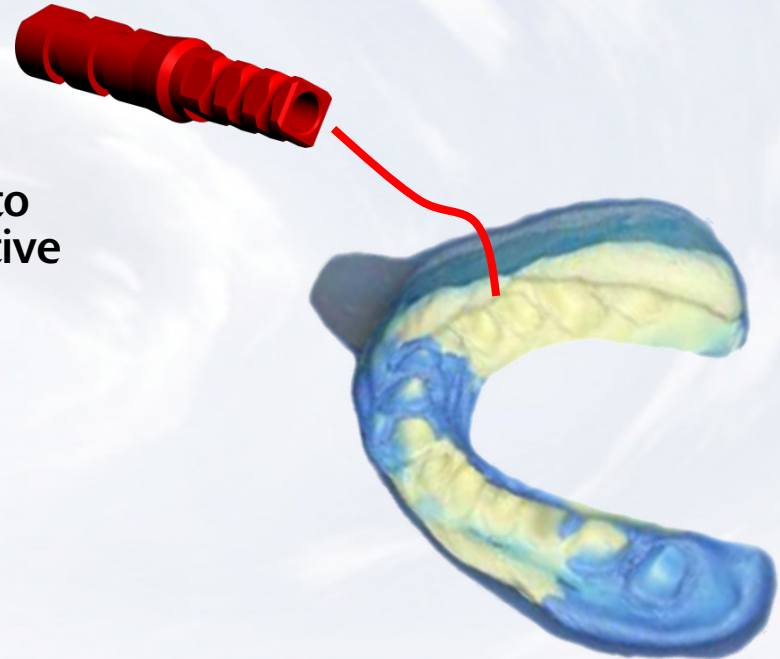

Insert transfer/analogue assembly into impression



Blue Sky Bio

UCLA Screw Retained Crown for Tissue Level Implant

Make sure to align the flats within the rubber of the impression with the flats on the implant level impression coping

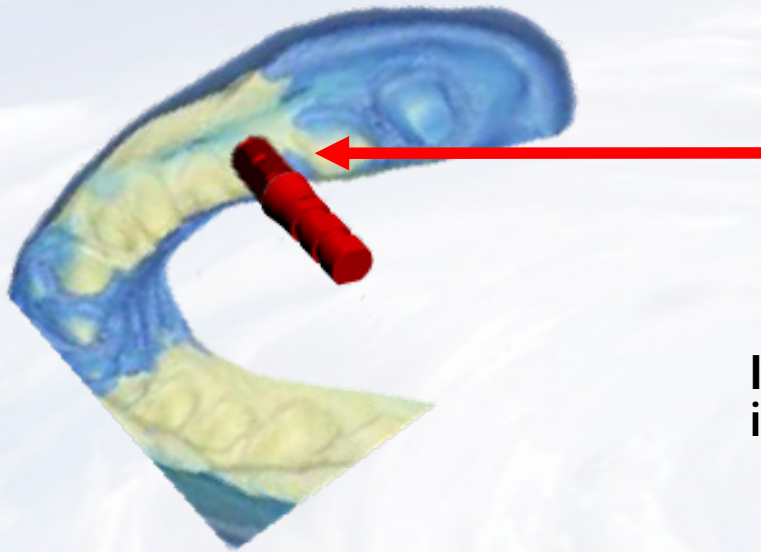

Impression transfer/analog inside impression

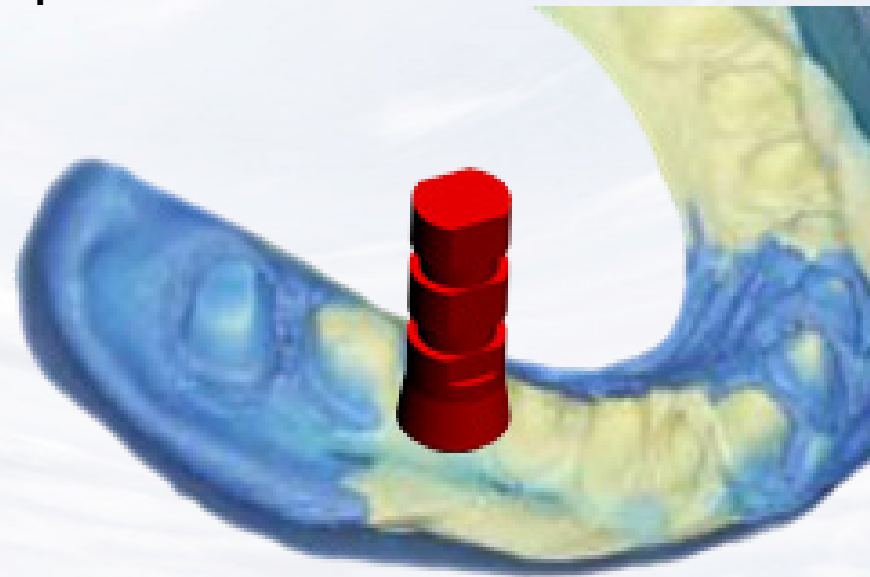

Blue Sky Bio

UCLA Screw Retained Crown for Tissue Level Implant

Apply soft tissue replica material around implant level analog



Pour dental Straight into impression



Blue Sky Bio

UCLA Screw Retained Crown for Tissue Level Implant

Remove model from impression and loosen the fixation screw of the impression transfer by turning screw driver counter clockwise

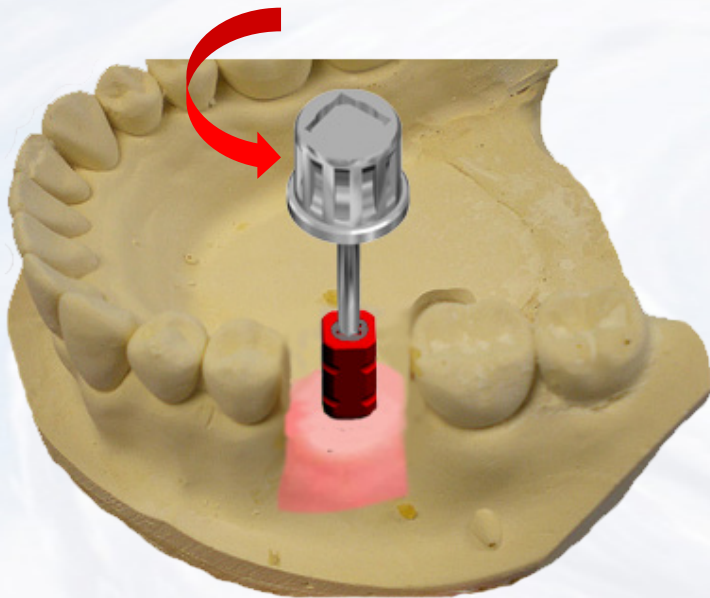

Remove impression transfer from analog

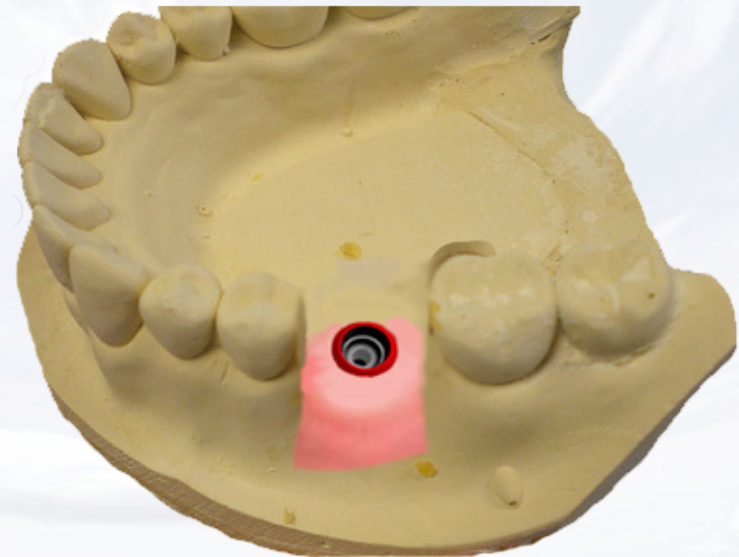

Blue Sky Bio

UCLA Screw Retained Crown for Tissue Level Implant



Insert screw driver assembly into fixation screw in the UCLA abutment

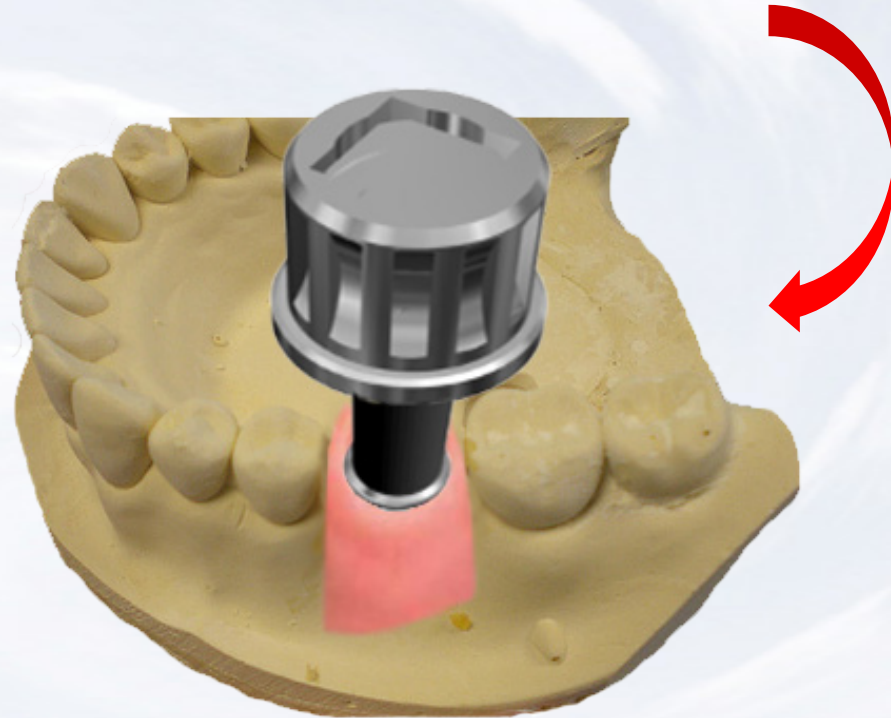

Insert abutment into implant level analog and align the male octagon of the abutment with the female octagon of the implant level analog. Turn the fixation screw within the abutment clockwise (the abutment will remain stationary.)

UCLA Screw Retained Crown for Tissue Level Implant

Create a wax up of the desired shape of the abutment by subtracting or adding to the plastic of the UCLA abutment



Completed custom cast abutment made from the wax up of the UCLA abutment



Blue Sky Bio

UCLA Screw Retained Crown for Tissue Level Implant

Apply a seal to the top of the custom cast UCLA abutment

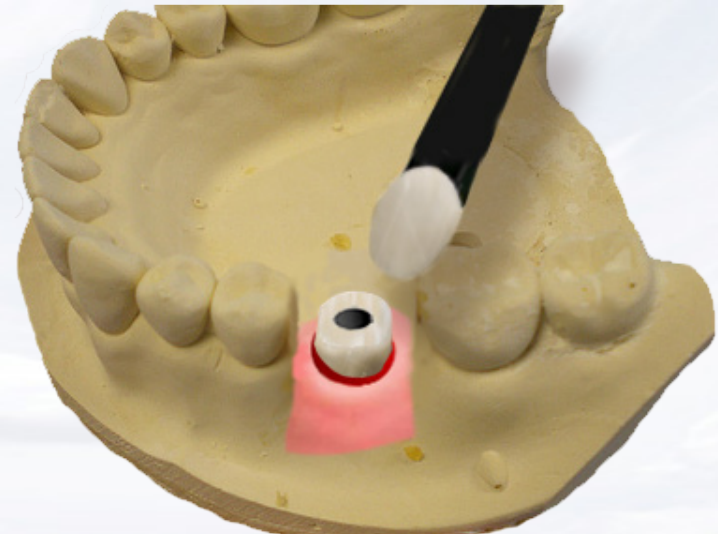
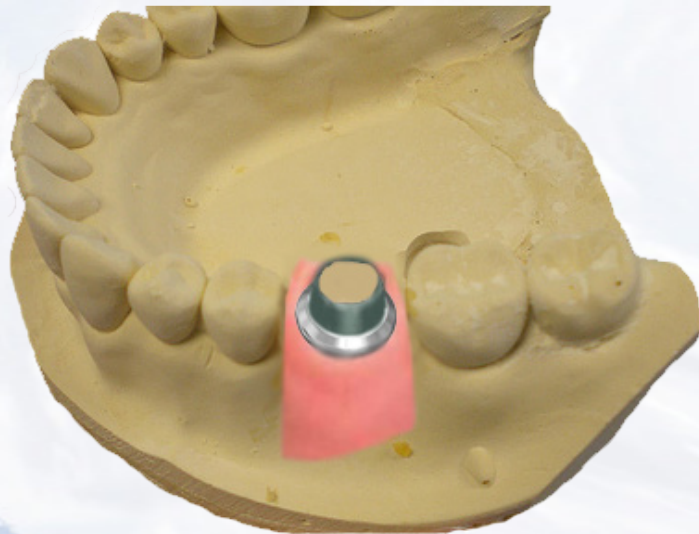

Blue Sky Bio

UCLA Screw Retained Crown for Tissue Level Implant

Build and fire the Ceramic in the usual manner

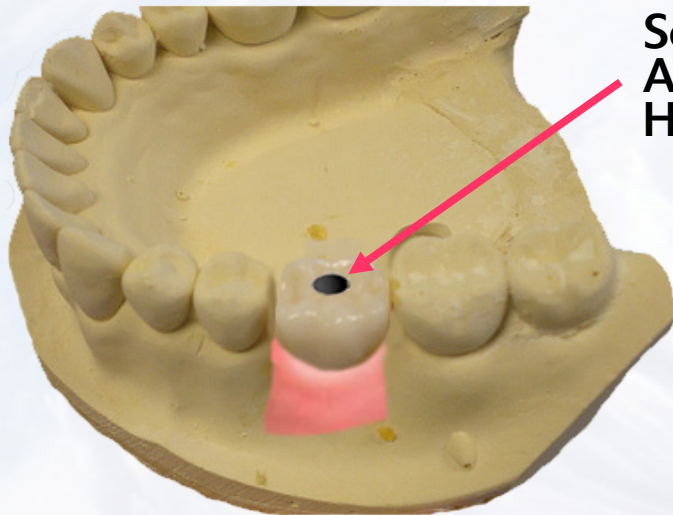

Use the screw driver assembly to insert the crown



Blue Sky Bio

UCLA Screw Retained Crown for Tissue Level Implant

Insert driver into the abutment screw and turn torque ratchet clockwise until torque of 30 Ncm is reached and the head of the ratchet releases



Insert the hex driver within the 30Ncm torque ratchet

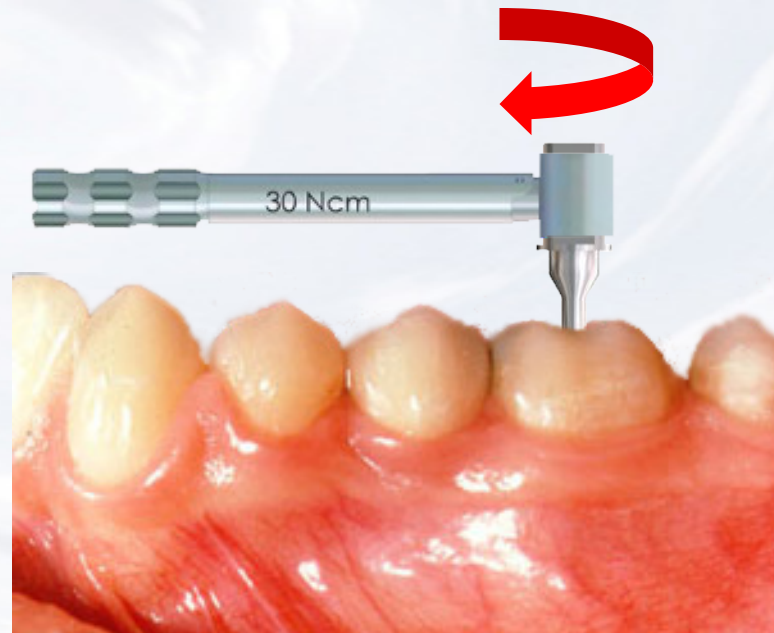

Blue Sky Bio